

ISL8120EVAL4Z Evaluation Board Setup Procedure

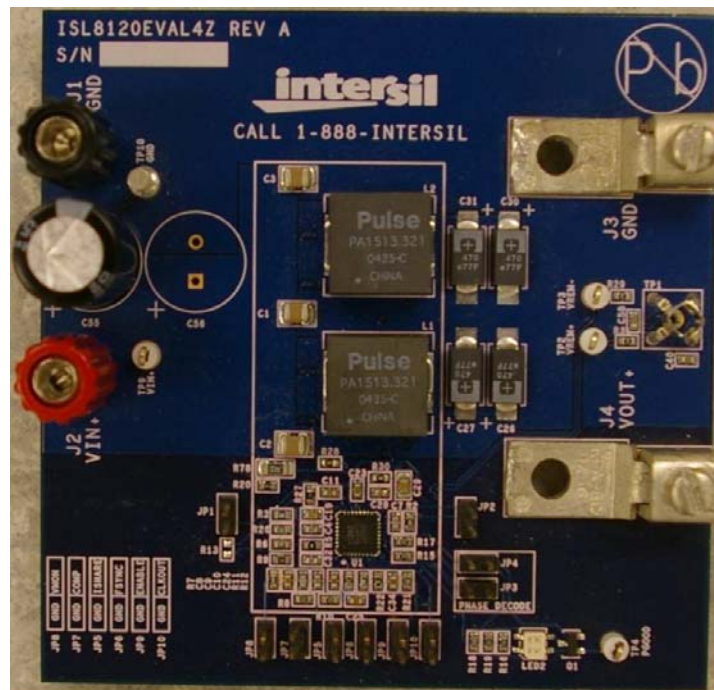

FIGURE 1. ISL8120EVAL4Z EVALUATION BOARD

The ISL8120 integrates two voltage-mode synchronous buck PWM controllers. It can be used either for dual independent outputs or a 2-phase single-output regulator.

The ISL8120EVAL4Z evaluation board is used for performance demo of 2/n-phase single-output applications. This application note introduces the setup procedure and performance of the ISL8120EVAL4Z evaluation board.

The ISL8120EVAL3Z evaluation board is for performance demo of dual independent outputs and DDR applications. Refer to application note [AN1528](#) "ISL8120EVAL3Z Evaluation Board Setup Procedure" for details of the ISL8120EVAL3Z board.

Recommended Equipment

- 0V to 22V power supply with at least 20A source current capability, battery, or notebook AC adapter.
- Two electronic loads capable of sinking current up to 30A.
- Digital multi-meters (DMMs).
- 100MHz quad-trace oscilloscope.

Circuits Description

J1 and J2 are the input power terminals.

J3 and J4 are output lugs for load connections.

The input electrolytic caps are used to handle the input current ripples.

Two upper and two lower Renesas "speed" series LFPK MOSFETs are used for each phase.

320nH PULSE surface mount inductors are used for each phase. Under the 500kHz setup, the inductor current peak-to-peak ripple is 7.5A at 12V input and 1.2V output.

Four SANYO POSCAP 2R5TPF470M7L (7mΩ) are used as output E-caps.

TP2 and TP3 are remote sense posts. These pins can be used to monitor and evaluate the system voltage regulations. If the user want to use these test posts for remote sense, the R29 and R31 need to be changed to higher values, such as 10Ω. Also, the related voltage sense divider needs to be increased to a higher resistance, such as 1k.

TP1 is a test socket to hold the scope probe to check the output waveforms.

JP9 is used to disable the part.

JP6 is for connection of inputs of clock signal for the part to be synchronized with.

JP5 is used for connection of ISHARE signals of multiple boards in parallel operation applications.

JP3, JP4, R15 and R17 are used to set up the phase shift between the 2 phases of the IC.

R27 is used to isolate the noise at PVCC caused by driving. In 3.3V applications, it is recommended to short R27 to 0 in order to prevent VCC from dropping below POR under low input voltage.

Quick Start

1. Ensure that the circuit is correctly connected to the supply and loads prior to applying any power.
2. Adjust the input supply to be 12V. Turn on the input power supply.
3. Verify the output voltage is 1.2V. If PGOOD is set high, the LED2 will be green. If PGOOD is set low, the LED2 will be red. TP4 is the test post to monitor PGOOD.

Evaluating the Other Output Voltage

The ISL8120EVAL4Z kit output is preset to 1.2V/50A. V_{OUT1} can also be adjusted between 0.6V to 3V by changing the value of R26 and R6 for V_{OUT} , as given by Equation 1. The same rule applies for V_{OUT2} .

$$R26 = \frac{R6}{(V_{OUT}/V_{REF}) - 1} \quad \text{where } V_{REF} = 0.6V \quad (\text{EQ. 1})$$

Programming the Input Voltage UVLO and its Hysteresis

By programming the voltage divider at the EN/FF pin connected to the input rail, the input UVLO and its hysteresis can be programmed. The ISL8120EVAL4Z has R20 4.32k and R21 1.62k; the IC will be disabled when input voltage drops below 2.94V and will restart until V_{IN} recovers to be above 3.2V.

For 12V applications, it's suggested to have R20 24.9k and R21 2.43k, of which the IC is disabled when the input voltage drops below 9V and will restart until V_{IN} recovers to be above 10.5V.

Refer to equations on page 22 of the ISL8120 datasheet ([FN6641](#)) to program the UVLO falling threshold and hysteresis. The equations are re-stated here in Equations 2 and 3, where R_{UP} and R_{DOWN} are the upper and lower resistors of the voltage divider at EN/FF pin, V_{HYS} is the desired UVLO hysteresis and V_{FTH} is the desired UVLO falling threshold.

$$R_{UP} = \frac{V_{HYS}}{I_{HYS}} \quad \text{where } I_{HYS} = 2x30\mu A \quad (\text{EQ. 2})$$

$$R_{DOWN} = \frac{R_{UP} \cdot V_{ENREF}}{V_{FTH} - V_{ENREF}} \quad \text{where } R_{ENREF} = 0.8V \quad (\text{EQ. 3})$$

Note the ISL8120 EN/FF pin is a triple function pin and the voltages applied to the EN/FF pins are also fed to adjust the amplitude of each channel's individual sawtooth.

Parallel Operation for Current Sharing Application

The ISL8120 regulator outputs can be paralleled with current sharing control capability. The configuration for parallel operation is shown in Typical Application VIII in the datasheet. For this eval board, follow the following steps to set up the parallel operation of 2 boards.

1. Change R5 to 100Ω for both boards.
2. Use 2 wires (ISHARE, GND) connecting the ISHARE signals of the 2 boards through JP5.
3. Use 2 wires (EN/FF, GND) connecting the EN/FF signals of the 2 boards through JP9.
4. Use 2 wires connecting from JP10 (CLKOUT, GND) of one board to JP6 (FSYNC, GND) of another board.
5. Connecting the power supply to the inputs of the 2 boards.
6. Connecting the output of the 2 boards together and apply the loads.

Figure 2 shows the setup picture of 2 boards in parallel operation.

Application Note 1607

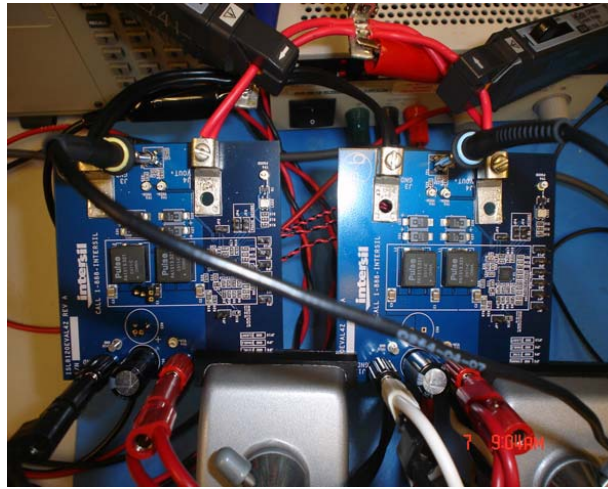
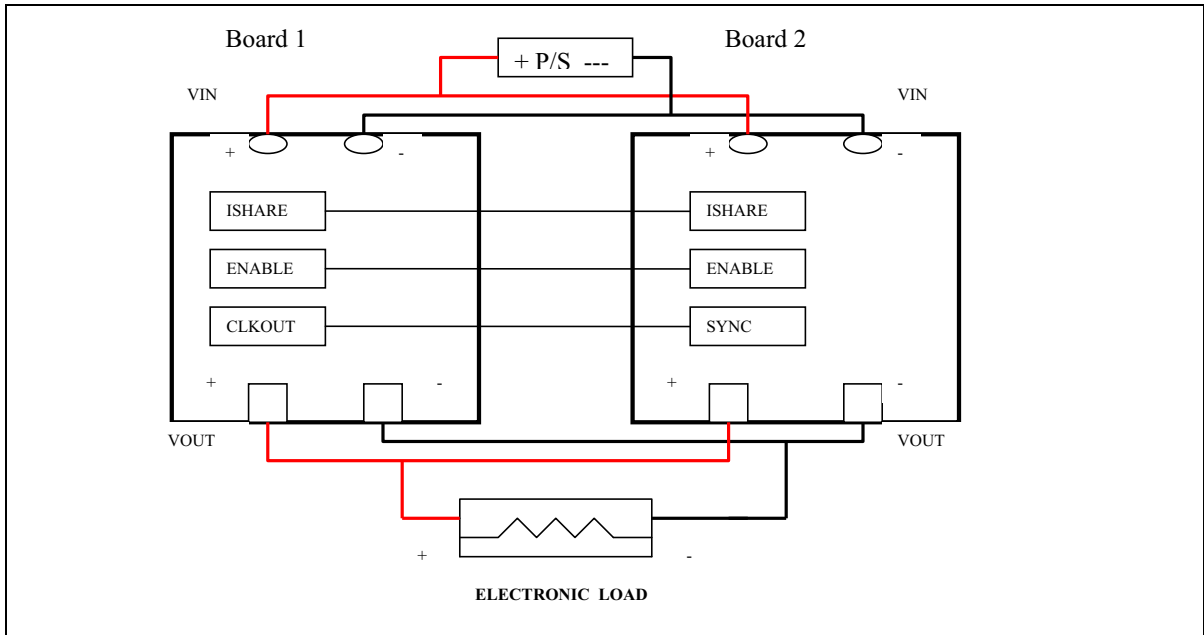

FIGURE 2. PARALLEL OPERATION SETUP

Application Note 1607

ISL8120EVAL4Z Bill of Materials

REF DES	PART NUMBER	QTY	MANUFACTURER	DESCRIPTION
C32		1	VARIOUS	CAP, SMD, 0603, 100pF, 50V, 5%, COG, ROHS
C24, C25, C34		3	VARIOUS	CAP, SMD, 0603, 1000pF, 16V, 10%, X7R, ROHS
C58, C59, C60		3	VARIOUS	CAP, SMD, 0603, 1μF, 16V, 10%, X5R, ROHS
C40		1	VARIOUS	CAP, SMD, 0603, 1μF, 16V, 10%, X5R, ROHS
C23		1	VARIOUS	CAP, SMD, 0603, 10μF, 6.3V, 20%, X5R, ROHS
C10		1	VARIOUS	CAP, SMD, 0603, 150pF, 50V, 5%, NPO, ROHS
C8		1	VARIOUS	CAP, SMD, 0603, 15000pF, 16V, 10%, X7R, ROHS
C9		1	VARIOUS	CAP, SMD, 0603, 2200pF, 50V, 5%, COG, ROHS
C11, C28		2	VARIOUS	CAP, SMD, 0805, 1.0μF, 25V, 10%, X5R, ROHS
C19		1	VARIOUS	CAP, SMD, 0603, 2.2μF, 16V, 10%, X5R, ROHS
C4, C7, C18, C42		0	VARIOUS	CAP, SMD, 0603, DNP-PLACE HOLDER
C5, C6, C22		3	VARIOUS	CAP, SMD, 0805, 1.0μF, 25V, 10%, X5R, ROHS
C29		1	VARIOUS	CAP, SMD, 0805, 4.7μF, 25V, 10%, X5R, ROHS
C16, C20, C21, C39		4	VARIOUS	CAP, SMD, 1206, 10μF, 16V, 10%, X5R, ROHS
C1, C2, C3		3	VARIOUS	CAP, SMD, 1210, 22μF, 25V, 10%, X5R, ROHS
C12, C13, C14, C15, C17, C33		0		CAP, SMD, 1210, DNP-PLACE HOLDER
C55	25ZL1500M12.5X25	1	RUBYCON	CAP, RADIAL, 12.5x25, 1500μF, 25V, 20%, ALUM. ELEC., ROHS
C56		0		DNP-PLACE HOLDER
C26, C27, C30, C31	2R5TPF470M7L	4	SANYO	CAP, POSCAP, SMD, 7.3x4.3, 470μF, 2.5V, 20%, 7mΩ, ROHS
L1, L2	PA1513.321NLT	2	PULSE	COIL-PWR INDUCTOR, SMD, 13mm, 320nH, 20%, 45A, Pb-Free
LED2	SSL-LXA3025IGC-TR	1	LUMEX	LED, SMD, 3x2.5mm, 4P, RED/GREEN, 12/20MCD, 2V
U1	ISL8120IRZ	1	INTERSIL	IC-DUAL PHASE PWM CONTROLLER, 32P, QFN, 5x5, ROHS
Q1	2N7002-7-F	1	DIODES, INC.	TRANSISTOR, N-CHANNEL, 3LD, SOT-23, 60V, 115mA, ROHS
Q5, Q6, Q9, Q10	RJK0301DPB	4	RENESAS TECHNOLOGY	TRANSISTOR, N-CHANNEL, 5P, LFPK, 30V, 60A, ROHS
Q3, Q4, Q7, Q8	RJK0305DPB	4	RENESAS TECHNOLOGY	TRANSISTOR, N-CHANNEL, 5P, LFPK, 30V, 30A, ROHS
R27		1	VARIOUS	RES, SMD, 0603, 5.1Ω, 1/10W, 1%, TF, ROHS
R5, R22, R29, R31		4	VARIOUS	RES, SMD, 0603, 5.1Ω, 1/10W, 1%, TF, ROHS
R7		1	VARIOUS	RES, SMD, 0603, 1k, 1/10W, 1%, TF, ROHS
R8, R10, R11, R15, R17, R18		6	VARIOUS	RES, SMD, 0603, 10k, 1/10W, 1%, TF, ROHS
R6, R26		2	VARIOUS	RES, SMD, 0603, 200Ω, 1/10W, 1%, TF, ROHS
R28, R30		2	VARIOUS	RES, SMD, 0603, 2k, 1/10W, 1%, TF, ROHS
R21		1	VARIOUS	RES, SMD, 0603, 1.62k, 1/10W, 1%, TF, ROHS
R16, R19		1	VARIOUS	RES, SMD, 0603, 3.3kΩ, 1/10W, 1%, TF, ROHS
R2, R3		2	VARIOUS	RES, SMD, 0603, 390Ω, 1/10W, 1%, TF, ROHS
R9		1	VARIOUS	RES, SMD, 0603, 45.3Ω, 1/10W, 1%, TF, ROHS
R1, R4		2	VARIOUS	RES, SMD, 0603, 6.49k, 1/10W, 1%, TF, ROHS
R12		1	VARIOUS	RES, SMD, 0603, 76.8k, 1/10W, 1%, TF, ROHS
R20		1	VARIOUS	RES, SMD, 0603, 4.32kΩ, 1/10W, 1%, TF, ROHS

ISL8120EVAL4Z Bill of Materials (Continued)

REF DES	PART NUMBER	QTY	MANUFACTURER	DESCRIPTION
R13		0	VARIOUS	RES, SMD, 0603, DNP-PLACE HOLDER, ROHS
R14, R25		0	VARIOUS	RES, SMD, 0805, DNP-PLACE HOLDER, ROHS
R78		1	VARIOUS	RES, SMD, 1206, 2Ω, 1/4W, 1%, TF, ROHS

ISL8120EVAL4Z Board Layout

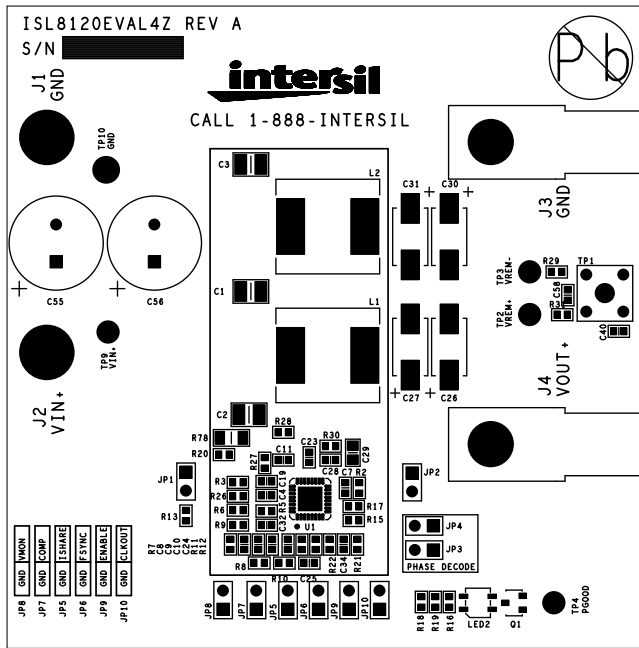

FIGURE 3. TOP SILKSCREEN

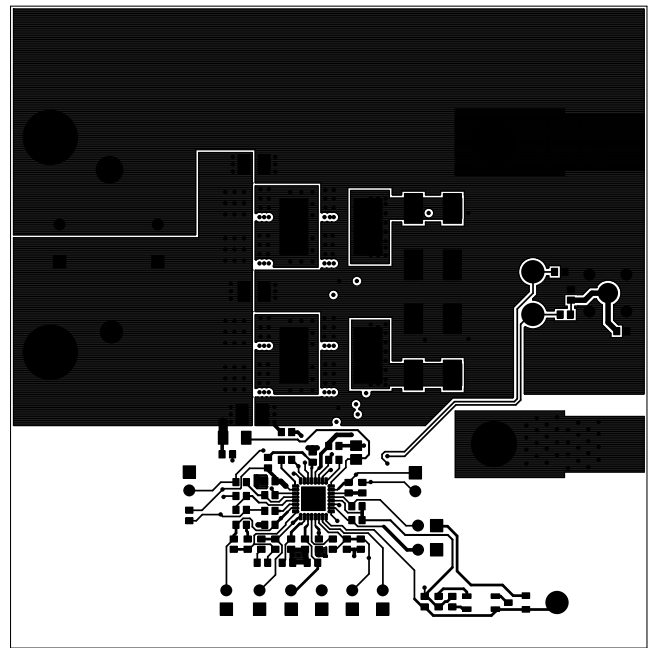

FIGURE 4. TOP LAYER

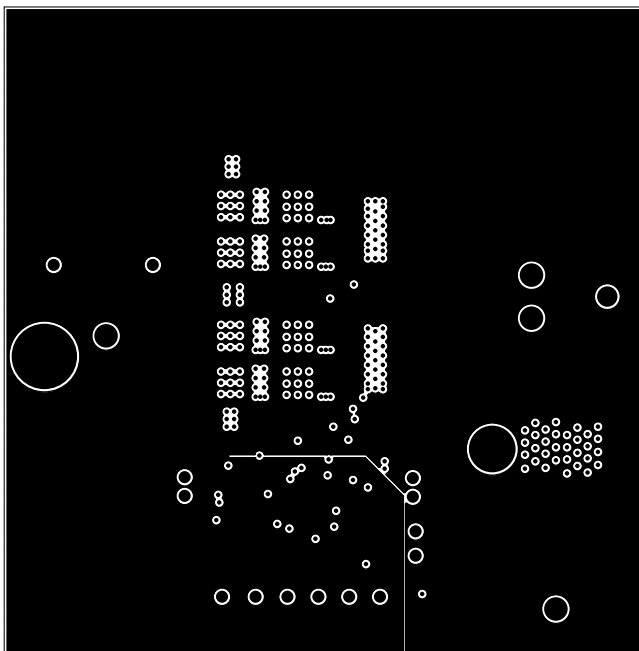

FIGURE 5. 2nd LAYER

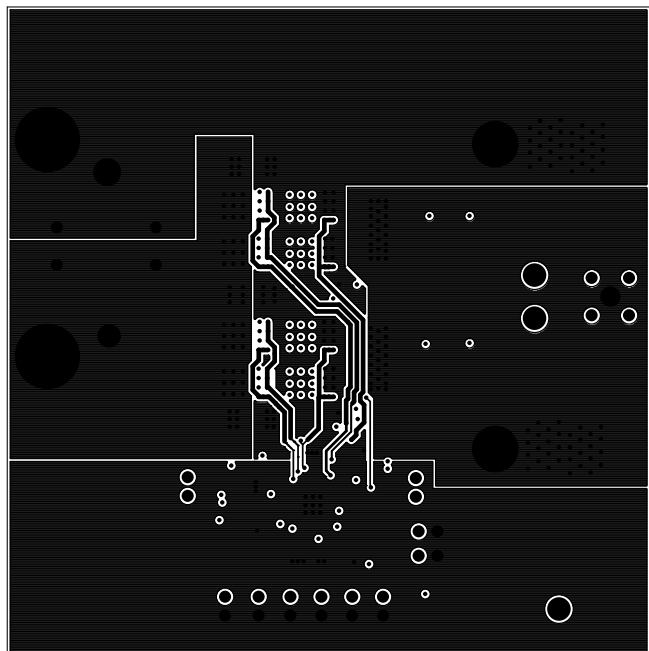

FIGURE 6. 3rd LAYER

ISL8120EVAL4Z Board Layout (Continued)

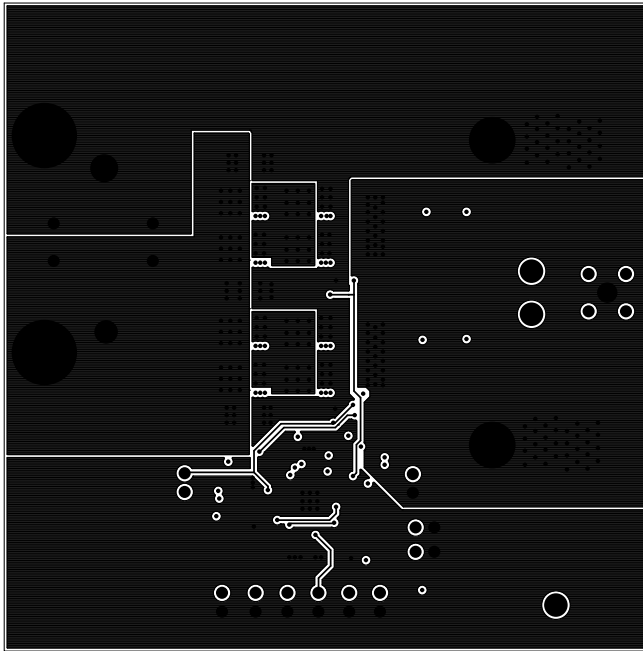

FIGURE 7. 4th LAYER

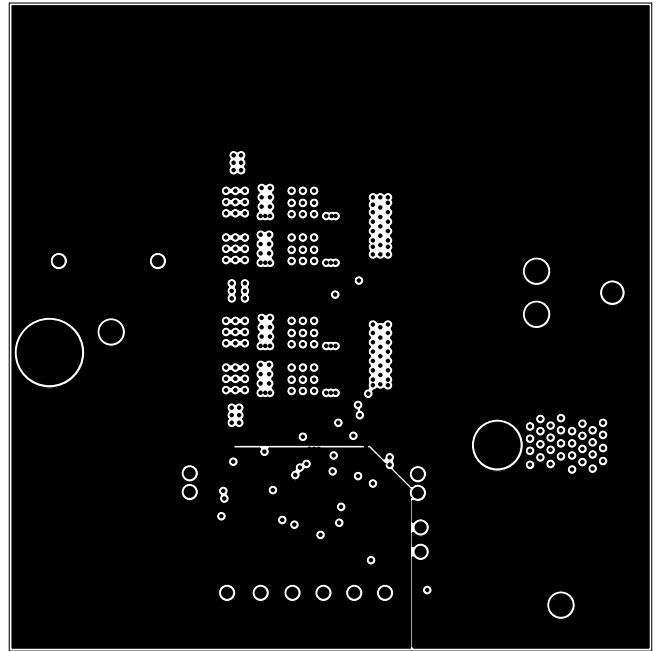

FIGURE 8. 5th LAYER

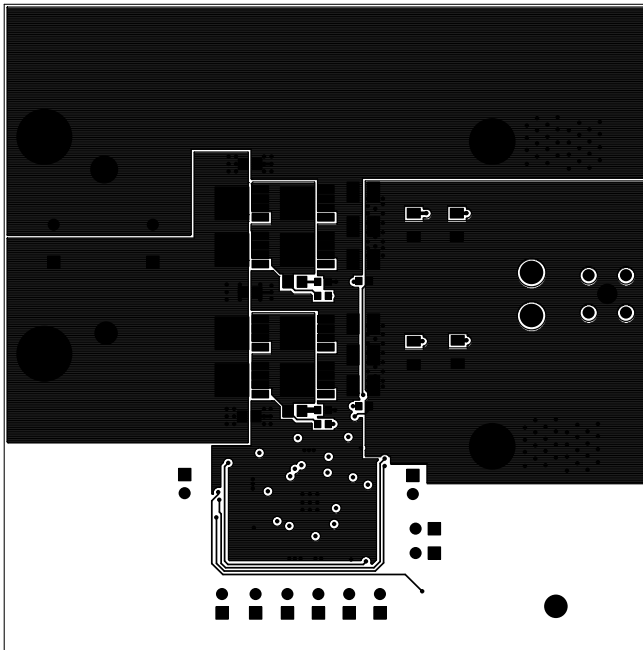

FIGURE 9. BOTTOM LAYER

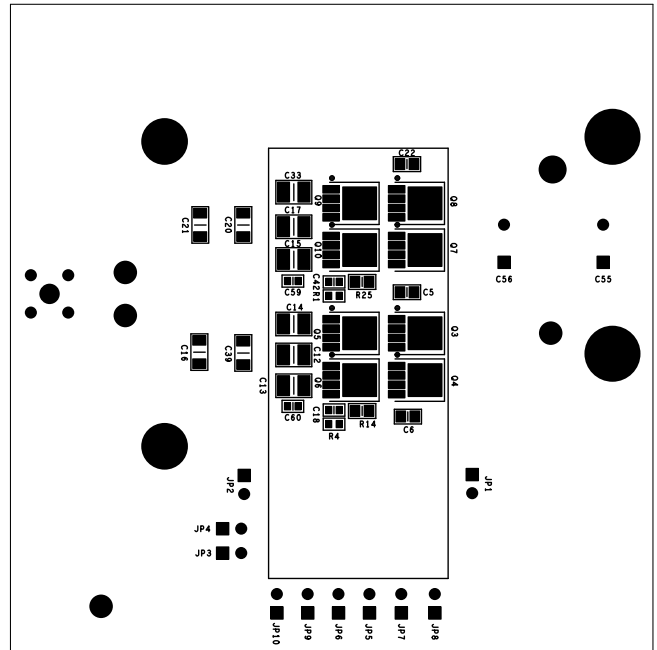

FIGURE 10. BOTTOM SILKSCREEN (MIRRORED)

ISL8120EVAL4Z Board Layout (Continued)

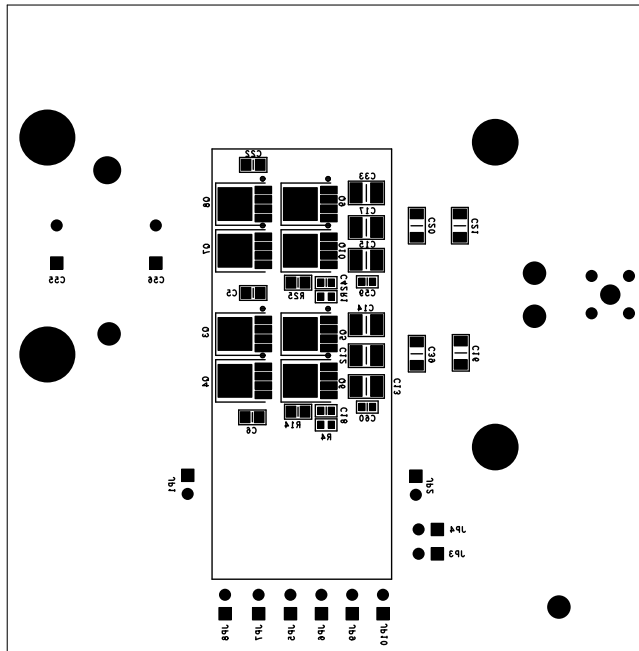

FIGURE 11. BOTTOM SILKSCREEN

Test Data for ISL8120EVAL4Z

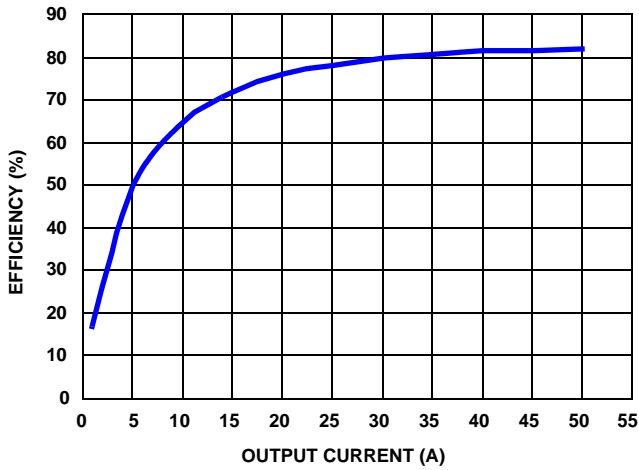

FIGURE 12. EFFICIENCY (12V V_{IN} AND 1.2V V_{OUT})

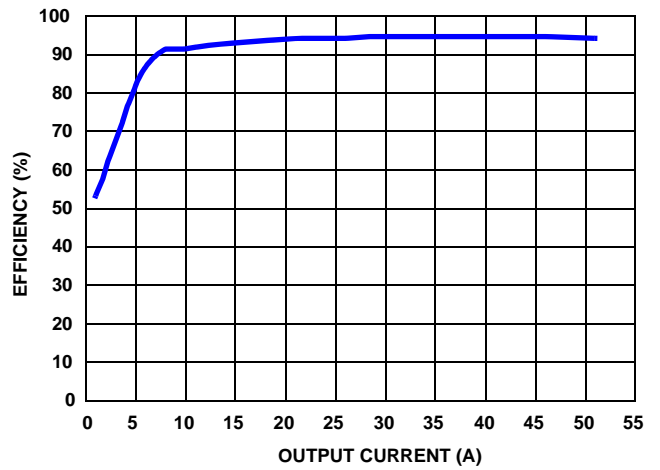

FIGURE 13. EFFICIENCY (12V V_{IN} AND 3.3V V_{OUT})

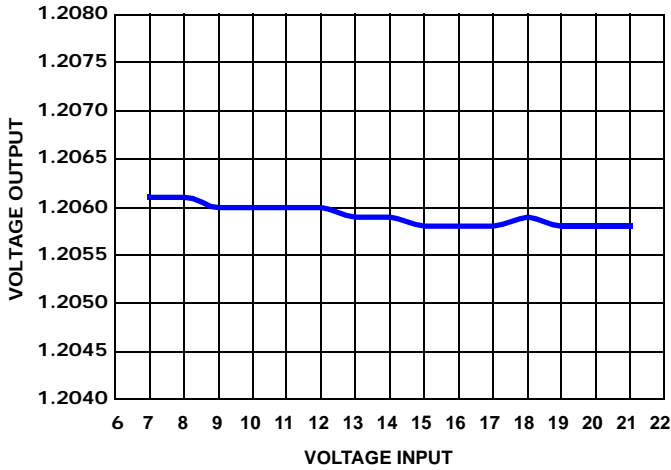

FIGURE 14. LINE REGULATION

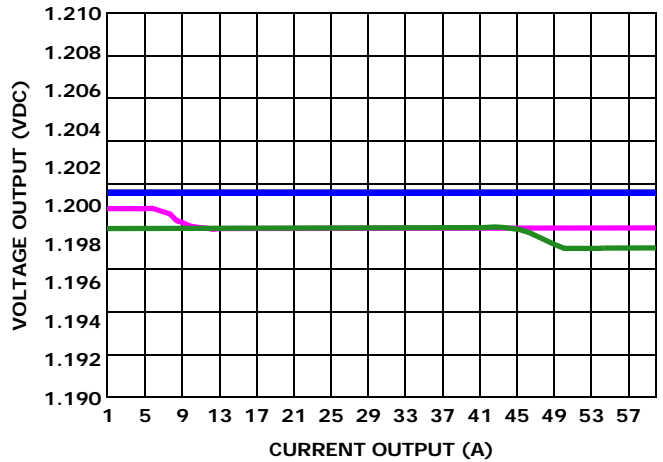

FIGURE 15. LOAD REGULATION

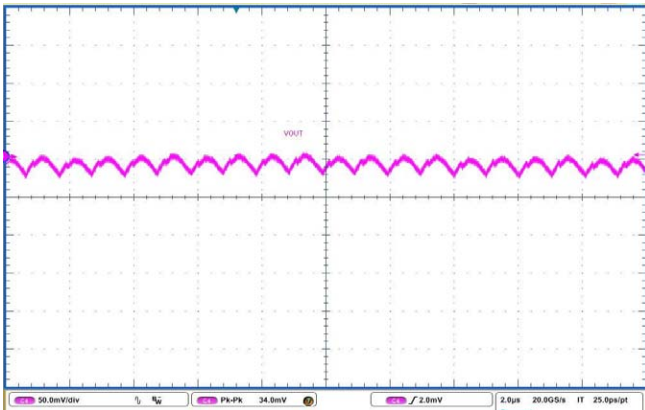

FIGURE 16. OUTPUTS RIPPLE UNDER 0A LOAD

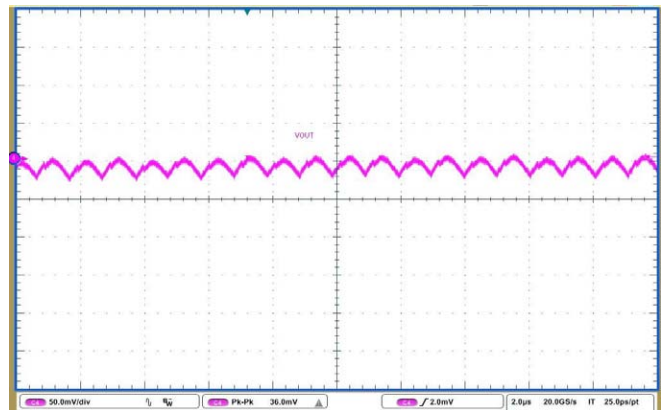

FIGURE 17. OUTPUTS RIPPLE UNDER 50A LOAD

Application Note 1607

Test Data for ISL8120EVAL4Z (Continued)

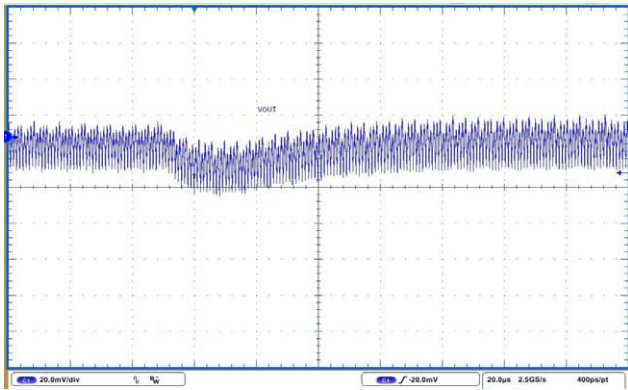

FIGURE 18. LOAD TRANSIENT (0A TO 50A STEP, SLEW_RATE = 2.5A/ μ s)

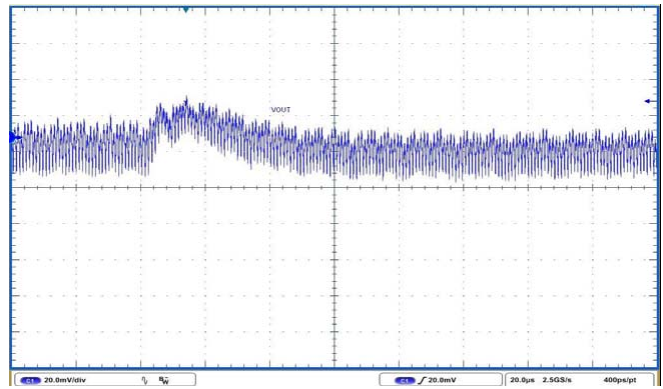

FIGURE 19. LOAD TRANSIENT (50A TO 0A STEP, SLEW_RATE = 2.5A/ μ s)

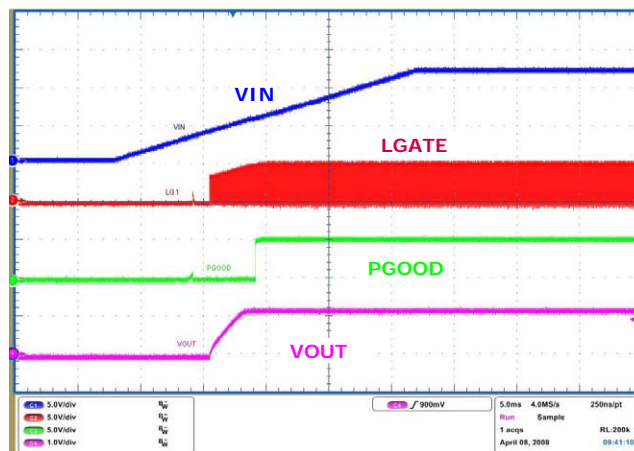

FIGURE 20. POWER-UP UNDER 50A FULL LOAD

Intersil Corporation reserves the right to make changes in circuit design, software and/or specifications at any time without notice. Accordingly, the reader is cautioned to verify that the Application Note or Technical Brief is current before proceeding.

For information regarding Intersil Corporation and its products, see www.intersil.com